

Instruction Manual

HI9146

Dissolved Oxygen and Temperature Meter

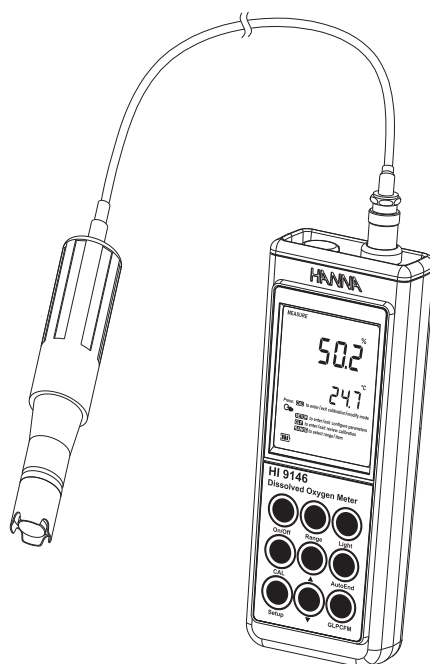

www.hannainst.com

Dear Customer,
 Thank you for choosing a Hanna Instruments product.
 Please read this instruction manual carefully before using the instrument.
 This manual will provide you with the necessary information for correct use of this instrument, as well as a precise idea of their versatility.
 If you need additional technical information, do not hesitate to e-mail us at tech@hannainst.com or view our worldwide contact list for a Hanna representative near you at www.hannainst.com.

WARRANTY

HI9146 is warranted for two years against defects in workmanship and materials when used for its intended purpose and maintained according to instructions. Electrodes and probes are warranted for six months. This warranty is limited to repair or replacement free of charge. Damage due to accidents, misuse, tampering or lack of prescribed maintenance is not covered.

If service is required, contact your local Hanna office. If under warranty, report the model number, date of purchase, serial number and the nature of the problem. If the repair is not covered by the warranty, you will be notified of the charges incurred. If the instrument is to be returned to Hanna Instruments, first obtain a Returned Goods Authorization (RGA) number from the Technical Service department and then send it with shipping costs prepaid. When shipping any instrument, make sure it is properly packaged for complete protection.

TABLE OF CONTENTS

WARRANTY	2
PRELIMINARY EXAMINATION	3
GENERAL DESCRIPTION	3
PROBE FUNCTIONAL DESCRIPTION	4
METER FUNCTIONAL DESCRIPTION	5
SPECIFICATIONS	7
OPERATIONAL GUIDE	8
AutoEnd	12
DO CALIBRATION	12
GOOD LABORATORY PRACTICE (GLP)	15
SETUP	17
DO CONCENTRATION VERSUS SALINITY CHART	18
DO CONCENTRATION VERSUS ALTITUDE CHART	19
TEMPERATURE CALIBRATION (for technical personnel only)	20
BATTERIES REPLACEMENT	21
LCD MESSAGE GUIDE	22
PROBE & MEMBRANE MAINTENANCE	23
TROUBLESHOOTING GUIDE	25
ACCESSORIES	26

PRELIMINARY EXAMINATION

Remove the instrument from the packing material and examine it carefully to make sure that no damage has occurred during shipping. If there is any damage, notify your Dealer or the nearest Hanna Customer Service Center.

Each instrument is supplied with:

- Polarographic DO probe
- **HI76407A** membrane cap (2 pcs.)
- **HI7041S** electrolyte solution (30 mL)
- 1.5V AAA, Batteries (3 pcs.)
- Instruction Manual
- Certificate
- Rugged Carrying Case

Note: Save all packing material until you are sure that the instrument functions correctly. All defective items must be returned in the original packing with the supplied accessories.

GENERAL DESCRIPTION

HI9146 is state-of-the-art, heavy-duty DO meter, designed to provide laboratory results and accuracy under harsh industrial conditions.

This instrument is provided with a series of new diagnostic features and messages on the LCD which add an entirely new dimension to the measurement of DO, by allowing the user to dramatically improve the reliability of the measurement.

The Auto Endpoint feature automatically freezes the display when a stable reading is reached.

Dissolved Oxygen is indicated in ppm (parts per million) or in %. All measurements are automatically compensated for temperature. Salinity compensation in water allows direct determination of Dissolved Oxygen in saline waters and altitude compensation readjusts for the altitude variance. The Dissolved Oxygen probe has a membrane covering the polarographic sensors and a built-in thermistor for temperature measurements and compensation. This permeable PTFE membrane isolates the sensor elements from the testing solution, but allows Oxygen to pass through. When a voltage is applied across the sensor, oxygen that has passed through the membrane reacts causing a current flow, and hence determining a reading.

The Battery Error Preventing System (BEPS) detects when the batteries become too weak to ensure reliable measurements.

The backlight feature is automatically disabled when batteries are getting low and a clear indication is displayed to warn the user of this condition. However, the meter continues to measure correctly even when the low battery indication is displayed. The meter automatically switches itself off when the batteries are too weak to support proper function.

In addition, the meter allow the user to enter an ID code to uniquely identify the instrument.

PROBE FUNCTIONAL DESCRIPTION

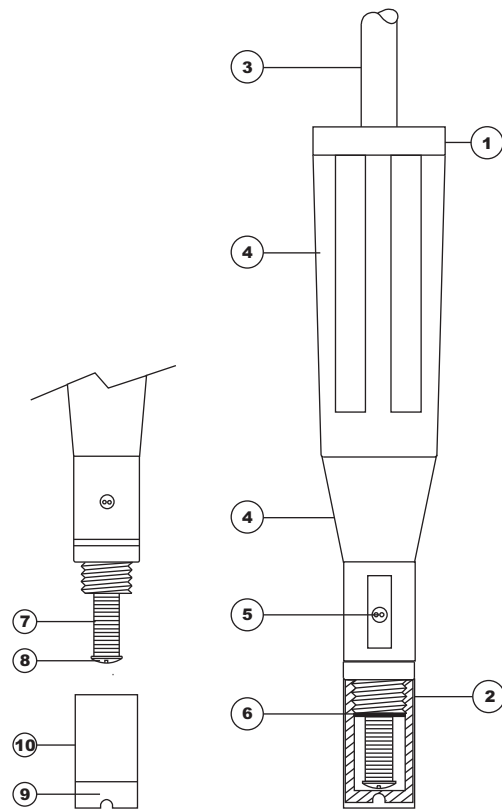

1. DO Probe
2. Protective Cap
3. Watertight Shielded Cable
4. Polypropylene Probe Body
5. Temperature Sensor
6. O-Ring Seal
7. Silver Chloride Anode
8. Platinum Cathode (sensor)
9. Oxygen Permeable PTFE Membrane
10. Membrane Cap

METER FUNCTIONAL DESCRIPTION

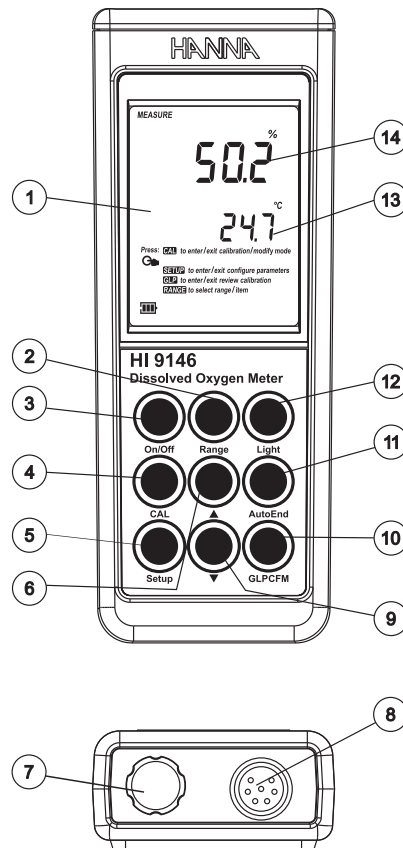

- 1) Liquid Crystal Display (LCD).
- 2) **Range** key, to select ppm or % range.
- 3) **On/Off** key, to turn the instrument ON and OFF.
- 4) **CAL** key, to enter/exit calibration mode.
- 5) **Setup** key, to enter/exit SETUP mode.
- 6) **▲** key, to manually increase temperature or other parameters.
- 7) Battery compartment cap.
- 8) DIN connector for DO probe.
- 9) **▼** key, to manually decrease temperature or other parameters.

- 10) **GLP** key, to display Good Laboratory Practice information.
CFM key, to confirm different values.
- 11) **AutoEnd** key, to freeze first stable reading on the LCD.
- 12) **Light** key, to toggle display backlighting.
- 13) Secondary LCD.
- 14) Primary LCD.

SPECIFICATIONS

RANGE	0.00 to 45.00 ppm
	0.0 to 300.0%
	0.0 to 50.0 °C / 32.0 to 122.0 °F
RESOLUTION	0.01 ppm
	0.1%
	0.1 °C / 0.1 °F
ACCURACY @ 25 °C / 77 °F	±1.5% of full scale or ±1 digit whichever is greater
	±0.2 °C / ±0.4 °F excluding probe error
DO Calibration	Single or double point at 0% (HI7040) and 100% (in air)
Altitude Compensation Resolution	0 to 4,000 m (13,120') 100 m (328')
Salinity Compensation Resolution	0 to 80 g/l 1 g/l
Temperature Compensation	0.0 to 50.0 °C (32.0 to 122.0 °F)
Probe	HI76407/4F with 4 m cable HI76407/10F with 10 m cable
Battery Type & Life	3 x 1.5V AAA batteries approx. 200 hours of continuous use without backlight (50 hours with backlight)
Dimensions	185 x 72 x 36 mm (7.3 x 2.8 x 1.4")
Weight	300 g (10.6 oz)
Environment	0 - 50 °C (32 - 122 °F) max RH 95% non condensing
Warranty	2 years

OPERATIONAL GUIDE

INITIAL PREPARATION

The instrument is supplied complete with batteries. In order to place the batteries inside the instrument follow the instructions from page 21.

To take measurements, connect the DO probe to the meter securely by aligning the pins with the socket located on the back of the meter, pushing the plug in and tightening the threaded ring.

Probes shipped from Hanna Instruments are dry. To hydrate the probe and prepare it for use, connect it to the meter and proceed as follows:

1. Remove the red and black plastic cap.
This cap is for shipping purposes and can be thrown away.
2. Wet the sensor by soaking the bottom 2½ cm (1") of the probe in electrolyte (HI7041S) for 5 minutes.
3. Rinse the membrane cap (HI76407A supplied in the kit with the meter) with electrolyte solution while shaking it gently. Refill with clean electrolyte solution.
4. Tap gently the sides of the membrane cap with your finger tip to ensure that no air bubbles are trapped. To avoid damaging the membrane, do not tap it directly on the bottom.
5. Make sure that the rubber O-Ring sits properly inside the membrane cap.
6. With the sensor facing down, slowly screw the cap clockwise. Some electrolyte will overflow.

When not in use and during polarization (see page 9), use the protective transparent cap supplied in the kit with the meter.

Shipping cap

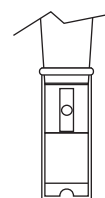
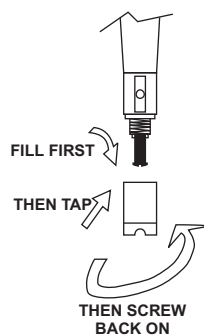

Turn the instrument ON by pressing On/Off.



At start-up the display will show all the used segments for a few seconds (or while the button is held), followed by the percentage indication of the remaining battery life.

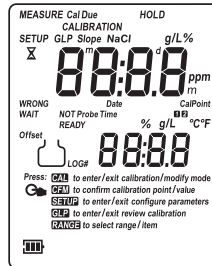

- After a few seconds “Cond” message appears, the “Σ” and “WAIT” tags will blink on the LCD if probe is connected to inform the user that the probe is in auto-conditioning (automatic polarization) mode.

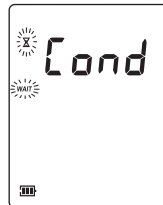

- When this message disappears, the probe is polarized and the instrument can be calibrated.
- The meter is now ready to operate.



- If the probe is disconnected or broken, the meter will display “----” and “NO Probe” tag blinking. In this situation only SETUP menu is available.

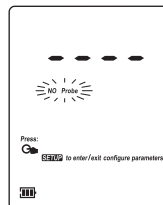

The auto-off feature turns the instrument off after a set period (default 20 min) with no button pressed to save battery life. To set another period or to disable this feature, see SETUP menu on page 17. The auto-off backlight feature turns the backlight off after a set period (default 1 min) with no buttons pressed. To set another period or to disable this feature, see SETUP menu on page 17.

PROBE POLARIZATION

The probe is under polarization with a fixed voltage of approximately 800 mV.

Probe polarization is essential for stable measurements with the same recurring degree of accuracy.

With the probe properly polarized, oxygen is continually consumed when it passes through the sensitive diaphragm and dissolves in the electrolyte solution contained in the probe.

If polarization is interrupted, the electrolyte solution continues to be enriched with oxygen until it reaches an equilibrium with the surrounding solution.

Whenever measurements are taken with a non-polarized probe, the oxygen level revealed is both that of the tested solution, as well as that present in the electrolyte solution. This reading is incorrect.

Keep the protective cap on during polarization time and remove it for calibration and measurements.

Note: If the probe is changed while the instrument is ON, a conditioning period is started.

SALINITY AND ALTITUDE COMPENSATION

If the sample contains significant concentration of salinity or if you are performing measurements at an altitude different from sea level, the read out values must be corrected, taking into account the lower degree of oxygen solubility in these situations (see pages 18-19).

Remember to set the altitude and/or the salinity before taking any DO measurements. The meter will automatically compensate for these factors.

DO MEASUREMENTS

Make sure that the instrument has been calibrated and the protective cap has been removed.

- Immerse the tip of the probe in the sample to be tested. Allow approximately one minute for the reading to stabilize.
- The Dissolved Oxygen value (in ppm) is displayed on the primary LCD and the temperature on the secondary LCD.



- Press **RANGE** to change the reading from ppm to % and vice-versa.

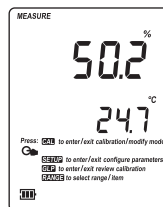

For accurate Dissolved Oxygen measurements, a water movement of 0.3 m/s is required. This is to ensure that the oxygen-depleted membrane surface is constantly replenished. A moving stream will provide adequate circulation.

The use of a magnetic stirrer to ensure a certain fluid velocity is recommended.

TEMPERATURE MEASUREMENTS

The probe has a built-in temperature sensor.

The measured temperature is indicated on the secondary LCD as shown above.

Allow the probe to reach thermal equilibrium before taking any measurement. This can take several minutes. The greater the difference between the temperature at which the probe was stored and the temperature of the sample, the longer the time will take to reach thermal equilibrium.

- Notes:**
- If “----” appears on the primary LCD and “NO Probe” is displayed blinking, the DO probe is not properly connected or the temperature is out of range. This also indicates the possibility of a broken probe cable.
 - If the temperature is out of range “°C” or “°F” tag is displayed blinking.
 - If the reading is out of range, the full scale value will be displayed blinking.
 - If the reading is not stable, the stability indicator “Σ” on.
 - Make sure the meter is calibrated before taking measurements.
 - If measurements are taken successively in different samples, to have accurate readings it is recommended to rinse the probe thoroughly with deionized water before immersion in the samples.
 - To maximize battery life, the meter is automatically switched off after a set period of non-use. To reactivate the instrument press the **On/Off** key. This feature can be disabled (see SETUP section for details).

BACKLIGHT FEATURE

The instrument is provided with a Backlight feature to enhance display readability in low light conditions. It can be easily toggled on and off through the keypad by pressing **Light**.



Note: The backlight automatically shuts off after a set time period to save battery life (see SETUP for details, page 17).

If battery percentage is less than 20% the backlight can not be ON.

AutoEnd

To freeze the first stable reading on the LCD press **AutoEnd** while the instrument is in measurement mode.



The "HOLD" tag will be displayed blinking on the LCD until the reading will stabilize.

When the reading is stable, the "HOLD" tag stops blinking and the reading is frozen on the LCD.

Press **AutoEnd** again to return to normal measurement mode.



- Note:**
- Pressing **Range** the instrument will skip to the displayed range, without leaving AutoEnd mode.
 - Pressing **Setup** then **GLP**, the instrument leaves AutoEnd mode and performs the selected function.

DO CALIBRATION

Calibrate the instrument frequently, especially if high accuracy is required. The instrument can be calibrated in maximum 2 points: 0.0% (**zero calibration**) and 100.0% (**slope calibration**).

The calibration of this instrument is very simple.

Before proceeding with the calibration, make sure the probe is ready for measurements (see page 8), i.e. the membrane cap is filled with electrolyte and the probe is connected to the meter and properly polarized.

For an accurate calibration, it is recommended to wait at least 15 minutes to ensure precise conditioning of the probe.

The zero calibration of the **HI9146** is very stable, therefore this procedure needs to be performed only whenever the probe or the membrane is replaced.

However, because the slope calibration is more critical, it is recommended to perform this procedure every week.



INITIAL PREPARATION

- Pour small quantities of HI7040 Zero Oxygen solution into a beaker. If possible, use a plastic beaker to minimize any EMC interferences.
- Make sure the probe is ready for measurements (see probe preparation on page 8), i.e. the membrane is filled with electrolyte and the probe is connected to the meter.
- Switch the meter on by pressing the **On/Off** key.
- For an accurate calibration, it is recommended to wait for at least 15 minutes to ensure precise conditioning of the probe.
- Remove the protective cap from the DO probe.
- Set the appropriate altitude factor (see page 19). Make sure the salinity factor is set to zero (see page 18).

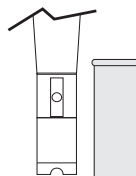

ZERO CALIBRATION

- Submerge the probe into HI7040 zero oxygen solution and stir gently for 2-3 minutes.



- Press **CAL**. The “X” and “NOT READY” tags will blink on the LCD until the reading is stable.

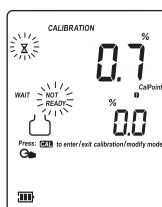

- When the reading is stable, and is within the limits ($\pm 15\%$ f.s.) “CFM” starts blinking. Press **CFM** to confirm the “0.0%” DO calibration.

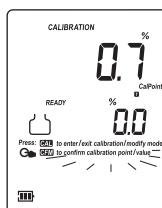

- Press **CAL**. The instrument will return to measurement mode and will memorize the zero calibration data. For a two-point calibration do not press **CAL** and follow the procedure below.



SLOPE CALIBRATION

It is suggested to perform the slope calibration in air.

- Rinse the probe in clean water to remove any residual zero oxygen solution.



Note: If you did not perform the zero calibration procedure, press **CAL** and then the **▲▼** keys to select the 100% DO calibration point.

- Dry the probe tip and allow a few seconds for the LCD reading to stabilize. The “**×**” and “**NOT READY**” tags will blink until the reading is stable.
- When the reading is stable, “**CFM**” tag starts blinking. Press **CFM** to confirm the “**100.0%**” DO calibration.
- If the reading is within the limits ($\pm 15\%$ f.s.), the meter stores the value (and adjusts the slope point).
- The instrument stores the slope calibration data and returns to measurement mode.



Note: • If the reading is not close to the selected calibration point, “**WRONG**” tag will blink.

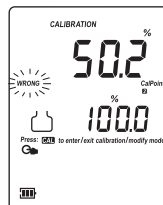

- If the temperature is out of range “**WRONG**” tag together with the temperature and “**C**” tag will blink.

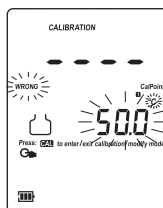

- **HI9146** has automatic buffer recognition function. If the **▲▼** keys are pressed to select the desired calibration value, the automatic buffer recognition function is disabled.

GOOD LABORATORY PRACTICE (GLP)

GLP is a set of functions that allows storage and retrieval of data regarding the maintenance and status of the probe.

All data regarding DO calibration is stored for the user to review when necessary.

LAST DO CALIBRATION DATA

The last DO calibration data is stored automatically after a successful calibration. To view the DO calibration data, press **GLP** when the instrument is in DO measurement mode.

The instrument will display the date (mm.dd) and the time (hh:mm) of the last calibration.



- Press **Setup** to view the year for a few seconds.



Press the ▲▼ keys to view the next calibration parameter.

Pressing the ▲ key:

- The calibration standards.

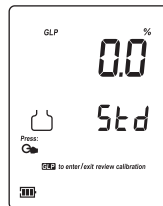

- Press **Setup** to view the temperature of the calibration for a few seconds.



- The altitude value.



- The salinity value.



Press **GLP** at any moment and the instrument will return to measurement mode.

SETUP

Setup mode allows viewing and modifying the following parameters:

- Salinity value (SAL)
- Altitude value (ALt)
- Current Time (hour & minute)
- Current Date (month, day & year)
- Beep Status (bEEP)
- Auto-off backlight (LIGH)
- Auto power of (AOFF)
- Temperature Unit

To enter SETUP mode, press **Setup** while the instrument is in measurement mode.

Select the desired setup parameter using the ▲▼ keys.

Press **CAL** if you want to change the item value. "CFM" tag and the selected item (e.g. hour, in setting up the correct time) will start blinking.

Press the ▲▼ keys to change the displayed value.

If there is another item to be set (e.g. minutes), press **Range**. The other item will start blinking.

Press the ▲▼ keys to change the displayed value.

Press **CFM** to confirm or **CAL** to escape.

Press the ▲▼ keys to select the next/previous parameter.

Press **Setup** to exit SETUP menu at any time.

The following table lists the SETUP parameters, their valid values range and the factory settings (default):

Item	Description	Valid values	Default
SAL	Salinity value	0 to 80 g/L	0
ALt	Altitude value	0 to 4000 m	0
Time	Time (hh:mm)	00:00 to 23:59	00:00
Date	Date (mm.dd.yyyy)	01.01.2000 to 12.31.2099	01.01.2009
bEEP	Beep Status	ON/OFF	OFF
LIGH	Auto-off backlight	OFF or 1, 5, 10 min	1
AOFF	Auto power off	OFF or 5, 10, 20, 60 min	20
	Temperature Unit	°C or °F	°C

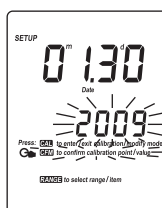
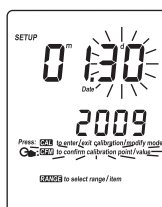

DISSOLVED OXYGEN CONCENTRATION VERSUS SALINITY CHART

Salinity affects the Dissolved Oxygen concentration expressed in ppm, decreasing its value. The table below shows the maximum oxygen solubility at various temperatures and salinity levels.

°C	Salinity (g/l) at Sea Level					°F
	0 g/l	10 g/l	20 g/l	30 g/l	35 g/l	
0	14.60	13.64	12.74	11.90	11.50	32.0
2	13.81	12.91	12.07	11.29	10.91	35.6
4	13.09	12.25	11.47	10.73	10.38	39.2
6	12.44	11.65	10.91	10.22	9.89	42.8
8	11.83	11.09	10.40	9.75	9.44	46.4
10	11.28	10.58	9.93	9.32	9.03	50.0
12	10.77	10.11	9.50	8.92	8.65	53.6
14	10.29	9.68	9.10	8.55	8.30	57.2
16	9.86	9.28	8.73	8.21	7.97	60.8
18	9.45	8.90	8.39	7.90	7.66	64.4
20	9.08	8.56	8.07	7.60	7.38	68.0
22	8.73	8.23	7.77	7.33	7.12	71.6
24	8.40	7.93	7.49	7.07	6.87	75.2
25	8.24	7.79	7.36	6.95	6.75	77.0
26	8.09	7.65	7.23	6.83	6.64	78.8
28	7.81	7.38	6.98	6.61	6.42	82.4
30	7.54	7.14	6.75	6.39	6.22	86.0
32	7.29	6.90	6.54	6.19	6.03	89.6
34	7.05	6.68	6.33	6.01	5.85	93.2
36	6.82	6.47	6.14	5.83	5.68	96.8
38	6.61	6.28	5.96	5.66	5.51	100.4
40	6.41	6.09	5.79	5.50	5.36	104.0
42	6.22	5.93	5.63	5.35	5.22	107.6
44	6.04	5.77	5.48	5.21	5.09	111.2
46	5.87	5.61	5.33	5.07	4.97	114.8
48	5.70	5.47	5.20	4.95	4.85	118.4
50	5.54	5.33	5.07	4.83	4.75	122.0

Note: The relationship between salinity and chlorinity for sea water is given by the equation below:

$$\text{Salinity (g/l)} = 1.80655 \text{ Chlorinity (g/l)}$$

DISSOLVED OXYGEN CONCENTRATION VERSUS ALTITUDE CHART

Altitude affects Dissolved Oxygen concentration expressed in ppm, decreasing its value. The table shows the maximum oxygen solubility at various temperatures and altitudes.

°C	Altitude, Meters above Sea Level															°F
	0 m	300 m	600 m	900 m	1200 m	1500 m	1800 m	2100 m	2400 m	2700 m	3000 m	3300 m	3600 m	3900 m	4000 m	
0	14.6	14.1	13.6	13.1	12.6	12.1	11.7	11.2	10.8	10.4	10.0	9.7	9.3	9.0	8.9	32.0
2	13.8	13.3	12.8	12.4	11.9	11.5	11.0	10.6	10.2	9.9	9.5	9.2	8.8	8.5	8.4	35.6
4	13.1	12.6	12.2	11.7	11.3	10.9	10.5	10.1	9.7	9.3	9.0	8.7	8.4	8.0	7.9	39.2
6	12.4	12.0	11.5	11.1	10.7	10.3	9.9	9.6	9.2	8.9	8.6	8.2	7.9	7.6	7.5	42.8
8	11.8	11.4	11.0	10.6	10.2	9.8	9.5	9.1	8.8	8.4	8.1	7.8	7.5	7.3	7.2	46.4
10	11.3	10.9	10.5	10.1	9.7	9.4	9.0	8.7	8.4	8.1	7.8	7.5	7.2	6.9	6.8	50.0
12	10.8	10.4	10.0	9.6	9.3	8.9	8.6	8.3	8.0	7.7	7.4	7.1	6.9	6.6	6.5	53.6
14	10.3	9.9	9.6	9.2	8.9	8.5	8.2	7.9	7.6	7.4	7.1	6.8	6.6	6.3	6.2	57.2
16	9.9	9.5	9.2	8.8	8.5	8.2	7.9	7.6	7.3	7.0	6.8	6.5	6.3	6.1	6.0	60.8
18	9.5	9.1	8.8	8.5	8.1	7.8	7.6	7.3	7.0	6.8	6.5	6.3	6.0	5.8	5.7	64.4
20	9.1	8.8	8.4	8.1	7.8	7.5	7.3	7.0	6.7	6.5	6.2	6.0	5.8	5.6	5.5	68.0
22	8.7	8.4	8.1	7.8	7.5	7.2	7.0	6.7	6.5	6.2	6.0	5.8	5.6	5.4	5.3	71.6
24	8.4	8.1	7.8	7.5	7.2	7.0	6.7	6.5	6.2	6.0	5.8	5.6	5.4	5.2	5.1	75.2
25	8.3	8.0	7.7	7.4	7.1	6.8	6.6	6.4	6.1	5.9	5.7	5.5	5.3	5.1	5.0	77.0
26	8.1	7.8	7.5	7.2	7.0	6.7	6.5	6.2	6.0	5.8	5.6	5.4	5.2	5.0	4.9	78.8
28	7.8	7.5	7.3	7.0	6.7	6.5	6.2	6.0	5.8	5.6	5.4	5.2	5.0	4.8	4.7	82.4
30	7.6	7.3	7.0	6.8	6.5	6.3	6.0	5.8	5.6	5.4	5.2	5.0	4.8	4.6	4.6	86.0
32	7.3	7.0	6.8	6.5	6.3	6.1	5.8	5.6	5.4	5.2	5.0	4.8	4.7	4.5	4.4	89.6
34	7.1	6.8	6.6	6.3	6.1	5.9	5.6	5.4	5.2	5.0	4.9	4.7	4.5	4.3	4.3	93.2
36	6.8	6.6	6.3	6.1	5.9	5.7	5.5	5.3	5.1	4.9	4.7	4.5	4.4	4.2	4.1	96.8
38	6.6	6.4	6.1	5.9	5.7	5.5	5.3	5.1	4.9	4.7	4.5	4.4	4.2	4.1	4.0	100.4
40	6.4	6.2	5.9	5.7	5.5	5.3	5.1	4.9	4.7	4.6	4.4	4.2	4.1	3.9	3.9	104.0
42	6.2	6.0	5.8	5.6	5.3	5.2	5.0	4.8	4.6	4.4	4.3	4.1	4.0	3.8	3.8	107.6
44	6.0	5.8	5.6	5.4	5.2	5.0	4.8	4.6	4.5	4.3	4.1	4.0	3.8	3.7	3.7	111.2
46	5.8	5.6	5.4	5.2	5.0	4.8	4.7	4.5	4.3	4.2	4.0	3.9	3.7	3.6	3.5	114.8
48	5.7	5.5	5.3	5.1	4.9	4.7	4.5	4.4	4.2	4.0	3.9	3.7	3.6	3.5	3.4	118.4
50	5.5	5.3	5.1	4.9	4.7	4.6	4.4	4.2	4.1	3.9	3.8	3.6	3.5	3.4	3.3	122.0

TEMPERATURE CALIBRATION (for technical personnel only)

All the instruments are factory calibrated for temperature.

Hanna's temperature probes are interchangeable and no temperature calibration is needed when they are replaced.

If the temperature measurements are inaccurate, temperature recalibration should be performed.

For an accurate recalibration, contact your dealer or the nearest Hanna Customer Service Center, or follow the instructions below.

- Prepare a vessel containing ice and water and another one containing hot water (at approximately 50 °C or 122 °F). Place insulation material around the vessels to minimize temperature changes.
- Use a calibrated thermometer with a resolution of 0.1 °C as a reference thermometer. Connect the DO probe to the appropriate socket.
- With the instrument off, press and hold down the **Range & ▼** keys, then power on the instrument. The "CALIBRATION" tag will appear and the secondary LCD will show "0.0 °C". The primary LCD will display the measured temperature or the "----" message, if the measured temperature is out of range.
- Immerse the temperature probe into the vessel with ice and water as close as possible to the reference thermometer. Allow a few seconds for the probe to stabilize.
- Use the ▲▼ keys to set the reading on the secondary LCD to that of ice and water, measured by the reference thermometer. When the reading is stable and close to the selected calibration point, "CFM" tag will blink.



- Press **CFM** to confirm. The secondary LCD will display "50.0 °C".
- Immerse the temperature probe into the second vessel as close as possible to the reference thermometer. Allow a few seconds for the probe to stabilize.
- Use the ▲▼ keys to set the reading on the secondary LCD to that of the hot water.
- When the reading is stable and close to the selected calibration point, "CFM" tag will blink.
- Press **CFM** to confirm. The instrument returns to measurement mode.



Note: If the reading is not close to the selected calibration point, "WRONG" tag will blink. Change the temperature probe and restart calibration.

BATTERIES REPLACEMENT

If the batteries become weak, the display will flash the battery symbol to advise the user that approx. 1 hour of working time is left.

It is recommended to change the batteries as soon as the battery indicator blinks (lower frequency).



To replace the batteries, follow the next steps:

- Turn OFF the instrument.
- Open the battery compartment cap (located on the top of the instrument).
- Remove old batteries.
- Insert three new 1.5V AAA batteries in the battery compartment, following the instructions on the rear of the instrument.
- Reattach the battery compartment cap.

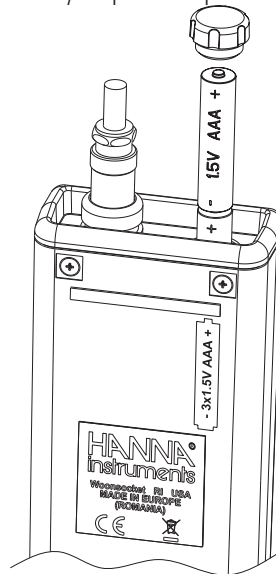

The instrument is provided with the BEPS (Battery Error Prevention System) feature, which automatically turns the instrument off when the batteries level is too low to ensure reliable readings. At start up the display will show “% 0 bAtt” message for a few seconds, then the instrument automatically turns off.

LCD MESSAGE GUIDE

TAGS & SYMBOLS

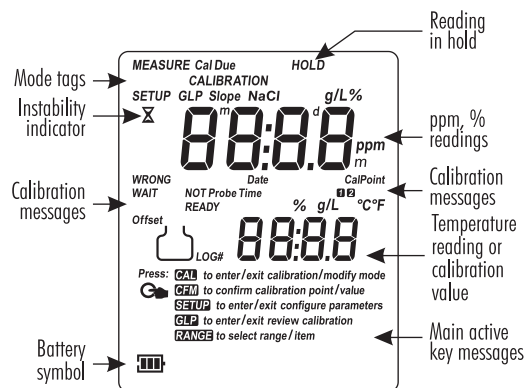

- **Mode tags** light up for indicating the corresponding active mode, and blink for warning the user.
 - MEASURE on:** Instrument in measurement mode.
 - SETUP on:** SETUP menu mode has been entered.
 - CALIBRATION on:** calibration mode has been entered.
 - GLP on:** GLP mode has been entered.
- **Reading in HOLD:**
 - HOLD on:** reading frozen in AutoEnd mode.
 - HOLD blinking:** reading unstable in AutoEnd mode.
- **“°C” or “°F” blinking:** temperature is out of range.
- **X blinking (while in calibration):** reading unstable.
- **Main active key messages** light up for indicating the corresponding active key.
 - CAL on:** CAL key available.
 - CFM blinking:** ask confirmation of calibration or set value.
 - SETUP on:** SETUP key available.
 - GLP on:** GLP key available.
 - RANGE on:** RANGE key available.
- **Battery symbol blinking:** low battery condition. The batteries should be replaced soon.

PROBE & MEMBRANE MAINTENANCE

The oxygen probe body is made of reinforced plastic for maximum durability.

A thermistor temperature sensor provides temperature measurements of the sample. Use the protective probe cap when not in use.

To replace the membrane or refill with electrolyte, proceed as follows:

- Remove the protective cap by gently twisting and pulling it off the body of the probe (see fig. 1).
- Unscrew the membrane cap by turning it counterclockwise (see fig. 2).
- Wet the sensor by soaking the bottom 2½ cm (1") of the probe in electrolyte (HI7041S) for 5 minutes.
- Rinse the new membrane cap (HI76407A), supplied with the meter with electrolyte solution while shaking it gently. Refill with clean electrolyte solution.
- Gently tap the sides of the membrane cap with your finger tip to ensure that no air bubbles remain trapped. Do not tap directly the bottom with your finger, as this will damage the membrane.
- Make sure that the rubber O-Ring sits properly inside the membrane cap.
- With the sensor facing down, slowly screw the membrane cap clockwise. Some electrolyte will overflow.

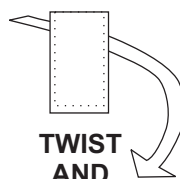

**TWIST
AND
PULL**

fig. 1

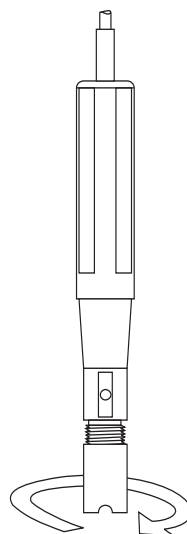

UNSCREW

fig. 2

The Platinum cathode (#8 in the Functional Description page 4) should always be bright and untarnished. If it is tarnished or stained, the cathode should be cleaned.

You can use a clean lint-free cardboard or cloth. Rub the cathode very gently side to side 4-5 times. This will be enough to polish and remove any stains without damaging the platinum tip. Afterwards, rinse the probe with deionized or distilled water and install a new membrane cap using fresh electrolyte and follow the steps above. Recalibrate the instrument.

IMPORTANT

In order to have accurate and stable measurements, it is important that the membrane surface is in perfect condition. This semipermeable membrane isolates the sensor elements from the environment but allows oxygen to enter. If any dirt is observed on the membrane, rinse carefully with distilled or deionized water. If any imperfections still exist, or any damage is evident (such as wrinkles or tears-holes), the membrane should be replaced.

Make sure that the O-Ring sits properly in the membrane cap.

TROUBLESHOOTING GUIDE

SYMPTOMS	PROBLEM	SOLUTION
Readings fluctuate up and down (noise).	DO probe not properly connected.	Insert the probe.
Display shows DO reading blinking.	Reading out of range.	Recalibrate the meter. Check the sample is within measurable range.
The meter fails to calibrate or gives faulty readings.	Broken probe.	Replace the probe.
At startup the meter displays all LCD tags permanently.	One of the keys is blocked.	Check the keyboard or contact the vendor.
"Err xx" error message is displayed and the meter turns off.	Internal error.	Power on the meter. If the error persists, contact the vendor.
Meter shuts off.	Dead batteries or Auto-off feature is enabled: in this case, meter shuts off after selected period of non use.	Replace the batteries. Press On/Off .
By pressing On/Off meter don't starts or don't stops.	Initialization error.	Press and hold down On/Off key for about 15 seconds. If the error persists, contact the vendor.
"CalDue" "Prod" message at startup.	Instrument not factory calibrated.	Contact Hanna Technical Support for factory calibration.

ACCESSORIES

HI98501	Digital thermometer (range: -50.0 to 150.0 °C / -58.0 to 302 °F)
HI7040L	Zero Oxygen Solution
HI7041S	Refilling Electrolyte Solution, 30 ml
HI76407A/P	Spare membranes (5 pcs.)
HI76407/4F	Spare DO probe with 4 m cable
HI76407/10F	Spare DO probe with 10 m cable

OTHER ACCESSORIES

HI740028P	1.5V AAA batteries (12 pcs.)
HI740036P	100 mL plastic beaker (10 pcs.)
HI740034P	Cap for 100 mL beakers (10 pcs.)

RECOMMENDATIONS FOR USERS

Before using these products, make sure they are entirely suitable for the environment in which they are used.

Operation of these instruments in residential areas could cause unacceptable interferences to radio and TV equipment, requiring the operator to follow all necessary steps to correct interferences.

During operation, ESD wrist straps should be worn to avoid possible damage to the electrode by electrostatic discharges.

Any variation introduced by the user to the supplied equipment may degrade the instruments' EMC performance.

To avoid electrical shock, do not use these instruments when voltages at the measurement surface exceed 24 Vac or 60 Vdc.

To avoid damage or burns, do not perform any measurement in microwave ovens.

Hanna Instruments reserves the right to modify the design, construction, or appearance of its products without advance notice.



Hanna Instruments Inc.
Highland Industrial Park
584 Park East Drive
Woonsocket, RI 02895 USA

Technical Support for Customers
Tel. (800) 426 6287
Fax (401) 765 7575
E-mail tech@hannainst.com
www.hannainst.com

Local Sales and Customer Service Office

